

Bottle Holder

Model CSHJ-1







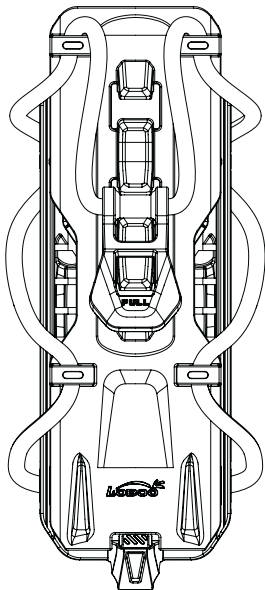



User Manual

*Please read this manual carefully before using this product to avoid improper use causing damage to the product.

Scan the code to watch the installation and usage tutorial video



Accessories List

<p>①</p>  <p>Quantity: 1 piece Bottle holder</p>	<p>②</p>  <p>Quantity: 2 pieces Clamp</p>	<p>③</p>  <p>Quantity: 4 pieces M5 x10 Torque: 5N-m</p>	<p>④</p>  <p>Quantity: 4 pieces M5 x10 Torque: 5N-m</p>
<p>⑤</p>  <p>Quantity: 4 pieces M5 gaskets</p>	<p>⑥</p>  <p>Quantity: 4 pieces O-ring Ø10x1.5</p>	<p>⑦</p>  <p>Quantity: 1 piece Drill fixture sticker</p>	<p>⑧</p>  <p>Quantity: 1 piece Ø5.5Twist drill bit</p>
<p>⑨</p>  <p>Quantity: 1 piece 3mm Hex wrench</p>	<p>⑩</p>  <p>Quantity: 1 piece 4mm Hex wrench</p>	<p>⑪</p>  <p>Quantity: 1 piece Screw glue</p>	

Notes :

- 1 . Please read the installation instructions in detail before installation.
2. When installing each component, do not tighten the fixing screws immediately.

After all components are installed, apply a suitable amount of thread locker to each screw, and then tighten all screws. Pay attention to the torque requirements for each screw (refer to the accessory table above).

3. Regularly check the fixing screws of each component.

Installation Method

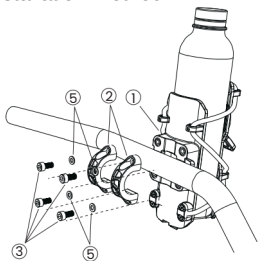

- I . Use the hexagonal handle ⑩, screw ③, and gasket ⑤ to fix the water bottle holder on the guardrail or frame with a diameter of 25mm through the clamp ②.

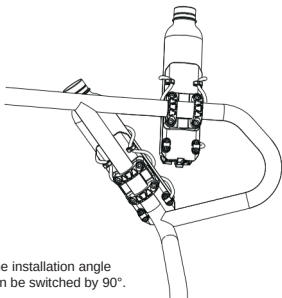

The installation angle can be switched by 90°.

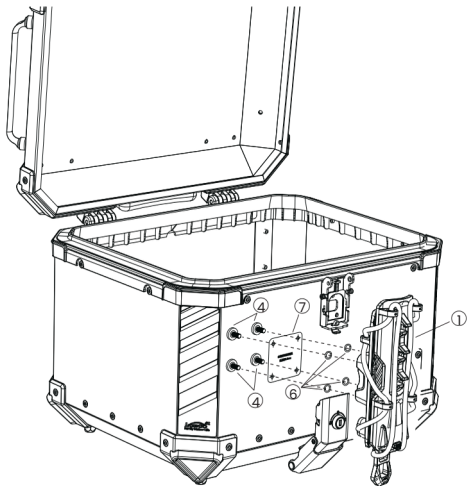

- II. When installing on the tail box and side box, please remove the lining bag before drilling. Stick the drilling fixture sticker ⑦ at an appropriate position on the box body, use the twist drill bit ⑧ to drill holes on the box body according to the cross mark specified by the drilling fixture sticker, then put the O-ring ⑥ into the circular groove on the back of the water bottle holder, and then use the hexagonal handle ⑨ and screw ④ to fix it from inside the box body.

Instructions for Use

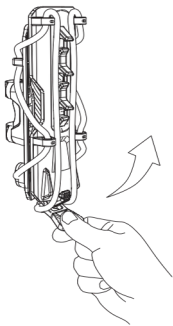

I . Pull out the handle
from the buckle.

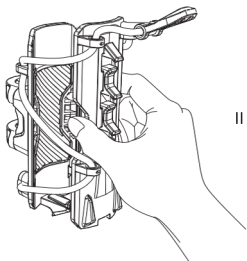

II . Open the water
bottle holder.

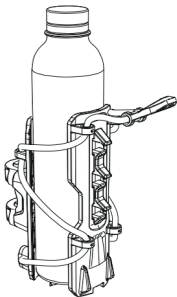

III. Put the water bottle into the water bottle holder.

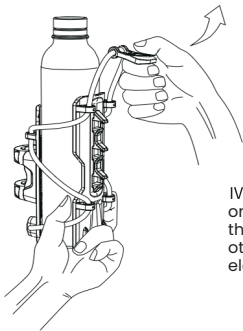

IV. Support the bottom with one hand, and pull up the handle with the other hand until the elastic rope is tightened.

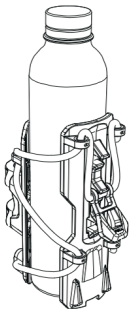

V . Buckle the handle in an appropriate gear.

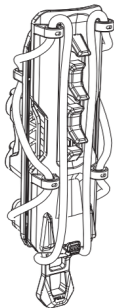

VI. After closing the holder, tighten the elastic rope and then buckle the handle in the bottom buckle to store it.

Warranty Card

When you need warranty service, please present this warranty card and fill in the relevant content in detail. Our company provides a 12-month free warranty period from the date of product purchase to the product use.

- Warranty Scope:**
- 1.Product quality problems occur under normal use.
 - 2.Damage to products caused by operational errors is not covered by warranty.
 - 3.Self-disassembly, modification, over-range use, etc, are not covered by warranty.
 - 4.Machines with altered body numbers and torn labels are not covered by warranty.

Please read the relevant after-sales service terms in detail before use. Unpacking and using it means accepting these after-sales service terms. If you do not agree with the above service terms, please do not use it and contact the dealer for a return. For products not covered by the warranty, our company can provide paid warranty services, the cost is based on the actual replacement material costs, and no labor costs are charged separately.

Product Model	CSHJ-1	Factory Number	
Purchase Date		Dealer	
Customer Name		Contact Number	
Customer Address			
Anomalies Description			

(This warranty card is valid for photocopy)